**EMC TEST REPORT****For****Shenzhen Wanlianxin Electronic Co., Ltd.****FINGERTIP PULSE OXIMETER****Model No: WLX501****WLX502,WLX503,WLX504,WLX505
WLX506,WLX507,WLX508,WLX509**

Prepared for : **Shenzhen Wanlianxin Electronic Co., Ltd.**
Address : Xingye Huating, 48 District, Haihua community, Xin'an street,
Bao'an District, Shenzhen 202
Prepared by : **Shenzhen BEL Technology Co., Ltd.**
Address : 3rd Floor, Xingfu Building, Tongfuyu Industrial Zone, Shiyan
Town, Bao'An District, Shenzhen, Guangdong, China

Report Number : **BEL20200000101899**
Date of Test : **May.18 - May.24, 2020**
Date of Report : **May.24, 2020**



TABLE OF CONTENT

	Page
Test Report Declaration	
1.GENERAL INFORMATION.....	5
1.1 Description of Device (EUT).....	5
1.2 Test Facility.....	5
1.3 Tested System Details.....	6
1.4 Test Uncertainty.....	6
2. TEST INSTRUMENT USED.....	7
2.1 For Conducted Emission Test.....	7
2.2 For Radiated Emission Test.....	7
2.3 For Harmonic & Flicker Test.....	8
2.4 For Electrostatic Discharge Immunity Test.....	8
2.5 For RF Field Strength Susceptibility Test.....	8
2.6 For Electrical Fast Transient /Burst Immunity Test.....	9
2.7.For Surge Test.....	9
2.8 For Injected Currents Susceptibility Test.....	9
2.9 For Magnetic Field Immunity Test.....	9
2.10 For Voltage Dips Interruptions Test.....	10
3. POWER LINE CONDUCTED EMISSION TEST.....	11
3.1.Block Diagram of Test Setup.....	11
3.2.Test Standard.....	11
3.3.Power Line Conducted Emission Limit.....	11
3.4.EUT Configuration on Test.....	11
3.5.Operating Condition of EUT.....	12
3.6.Test Procedure.....	12
3.7.Test Result.....	12
4. RADIATION EMISSION TEST.....	13
4.1 Block Diagram of Test Setup.....	13
4.2 Test Standard.....	14
4.3 Radiation Limit.....	14
4.4 EUT Configuration on Test.....	14
4.5 Operating Condition of EUT.....	14
4.6 Test Procedure.....	14
4.7 Test Result.....	15
5. ELECTROSTATIC DISCHARGE IMMUNITY TEST.....	16
5.1 Block Diagram of Test Setup.....	16
5.2 Test Standard.....	16
5.3 Severity Levels and Performance Criterion.....	16
5.4 EUT Configuration.....	17
5.5 Operating Condition of EUT.....	17
5.6 Test Procedure.....	17
5.7 Test Results.....	18
6.RF EM FIELD (KEY CARRIER) TEST.....	20
6.1 Block Diagram of Test Setup.....	20
6.2 Test Standard.....	20
6.3 Severity Levels and Performance Criterion.....	21
6.4 Operating Condition of EUT.....	21
6.5 Test Procedure.....	21
6.6 Test Results.....	22



7. ELECTRICAL FAST TRANSIENT/BURST IMMUNITY TEST..... 24

7.1 Block Diagram of EUT Test Setup..... 24

7.2 Test Standard..... 24

7.3 Severity Levels and Performance Criterion..... 24

7.4 EUT Configuration on Test..... 24

7.5 Operating Condition of EUT..... 25

7.6 Test Procedure..... 25

7.7 Test Results..... 25

8. SURGE TEST..... 26

8.1 Block Diagram of EUT Test Setup..... 26

8.2 Test Standard..... 26

8.3 Severity Levels and Performance Criterion..... 26

8.4 EUT Configuration on Test..... 26

8.5 Operating Condition of EUT..... 27

8.6 Test Procedure..... 27

8.7 Test Result..... 27

9. INJECTED CURRENTS SUSCEPTIBILITY TEST..... 28

9.1 Block Diagram of EUT Test Setup..... 28

9.2 Test Standard..... 28

9.3 Severity Levels and Performance Criterion..... 28

9.4 EUT Configuration on Test..... 29

9.5 Operating Condition of EUT..... 29

9.6 Test Procedure..... 29

9.7 Test Result..... 30

10. MAGNETIC FIELD IMMUNITY TEST..... 31

10.1 Block Diagram of Test Setup..... 31

10.2 Test Standard..... 31

10.3 Severity Levels and Performance Criterion..... 31

10.4 EUT Configuration on Test..... 32

10.5 Operating Condition of EUT..... 32

10.6 Test Procedure..... 32

10.7 Test Results..... 33

11. VOLTAGE DIPS AND INTERRUPTIONS TEST..... 34

11.1 Block Diagram of EUT Test Setup..... 34

11.2 Test Standard..... 34

11.3 Severity Levels and Performance Criterion..... 34

11.4 EUT Configuration on Test..... 35

11.5 Operating Condition of EUT..... 35

11.6 Test Procedure..... 35

11.7 Test Result..... 35

12. EUT TEST GRAPH..... 36

13. EUT PHOTOGRAPHS..... 37



TEST REPORT DECLARATION

Applicant: **Shenzhen Wanlianxin Electronic Co., Ltd.**

Xingye Huating, 48 District, Haihua community, Xin'an street, Bao'an District, Shenzhen 202

Manufacturer : **Shenzhen Wanlianxin Electronic Co., Ltd.**

Xingye Huating, 48 District, Haihua community, Xin'an street, Bao'an District, Shenzhen 202

EUT Description : **FINGERTIP PULSE OXIMETER**

MODEL NO : **WLX501**

Test Procedure Used:

EN 60601-1:2006+A12:2014

EN 60601-1-2:2015

The device described above is tested by Shenzhen BEL Technology Co., Ltd. to determine the maximum emission levels emanating from the device, the severe levels which the device can endure and EUT is performance criterion. The test results are contained in this test report. BEL Testing Service Co., Ltd. is assumed of full responsibility for the accuracy and completeness of these tests. Also, this report shows that the EUT is technically compliant with the EN 60601-1:2006+A12:2014 and EN 60601-1-2:2015.

This report applies to above tested sample only and shall not be reproduced in part without written approval of Shenzhen BEL Technology Co., Ltd.

Date of Test:

May.18 - May.24, 2020

Prepared by(Engineer) :

Allen wang

Reviewer(Quality Manager) :

Randy ell

Approved&Authorized Signer(Manager) :

Andy Shi





1.GENERAL INFORMATION

1.1 Description of Device (EUT)

EUT : **FINGERTIP PULSE OXIMETER**

Model Number : **WLX501**

Power Supply : **N/A**

Applicant : **Shenzhen Wanlianxin Electronic Co., Ltd.**

Address : Xingye Huating, 48 District, Haihua community, Xin'an street, Bao'an District, Shenzhen 202

Manufacturer : **Shenzhen Wanlianxin Electronic Co., Ltd.**

Address : Xingye Huating, 48 District, Haihua community, Xin'an street, Bao'an District, Shenzhen 202

Date of report : **May.24, 2020,**

Date of Test : **May.18 - May.24, 2020**

1.2 Test Facility

Site Description

Chamber : Certificated by FCC
&Shielded room Registration Number: 248337
December 07, 2006
Certificated by VCCI
Registration Number: R-2482
February 9, 2004
Certificated by TUV Rheinland
Registration Number: N/A
January 16, 2007
Certificated by IC
Registration Number: 117715
November 07, 2006
Certificated by Intertek
Registration Number: TMPSHA031
November 10, 2006

Name of Firm : Shenzhen BEL Technology Co., Ltd.

Site Location : 415# ChuangYe Building, No.7 ChuangYe 2 Road, 24 District Baoan, Shenzhen Guangdong China .



1.3 Tested System Details

Host Personal Computer	: HP	Monitor	: SONY
M/N	: A1580TW	M/N	: MNT1
Printer	: EPSON STYLUS	Keyboard (USB)	: Genuine
M/N	: P320A	M/N	: N/A
Modem	: ACEEX	FINGERTIP PULSE OXIMETER	: DETROIS
M/N	: DM-1414	M/N	: CM309

1.4 Test Uncertainty

Conducted Emission Uncertainty : $\pm 2.66\text{dB}$

Radiated Emission Uncertainty : $\pm 4.26\text{dB}$

2. TEST INSTRUMENT USED

2.1 For Conducted Emission Test

Conducted Emission Test (A --- site)					
Equipment	Manufacturer	MODEL#	SERIAL#	LASTCAL.	NEXT CAL.
EMI Receiver	Schwarzbeck	PCKL1528	1528-194	Oct. 20, 2019,	Oct. 19, 2020
LISN	Kyoritsu	KNW407	8-1789-4	Oct. 20, 2019,	Oct. 19, 2020
Spectrum Analyzer	ADVANTENT	R3132	160400093	Oct. 20, 2019,	Oct. 19, 2020
50Ω coaxial switch	Anritsu	MP59B	6200264417	Oct. 20, 2019,	Oct. 19, 2020
Pulse Limiter	R&S	ESH3-Z2	100681	Oct. 20, 2019,	Oct. 19, 2020

2.2 For Radiated Emission Test

Radiation Emission Test (966 chamber)					
Equipment	Manufacturer	MODEL#	SERIAL#	LASTCAL.	NEXT CAL.
Spectrum Analyzer	ADVANTENT	R3132	160400005	Oct. 20, 2019,	Oct. 19, 2020
Amplifier	Tsj	MLA-10K-B01-27	1205323	Oct. 20, 2019,	Oct. 19, 2020
Antenna	Schwarzbeck	VULB9160	9160-3206	Oct. 20, 2019,	Oct. 19, 2020
EMI Receiver	Schaffner	SCR3501	235	Oct. 20, 2019,	Oct. 19, 2020
Regulated Power supply	Schaffner	NT41	16216	Oct. 20, 2019,	Oct. 19, 2020
50Ω coaxial switch	Anritsu	MP59B	6200264416	Oct. 20, 2019,	Oct. 19, 2020



2.3 For Harmonic & Flicker Test

For Harmonic / Flicker Test (A --- site)					
Equipment	Manufacturer	MODEL#	SERIAL#	LASTCAL.	NEXT CAL.
Harmonic / Flicker Tester	Schaffner	CCN 1000-1	72472	Oct. 20, 2019,	Oct. 19, 2020
Power source	Schaffner	NSG 1007-5-208-413	57227	Oct. 20, 2019,	Oct. 19, 2020

2.4 For Electrostatic Discharge Immunity Test

For Electrostatic Discharge Immunity Test (A --- site)					
Equipment	Manufacturer	MODEL#	SERIAL#	LASTCAL.	NEXT CAL.
ESD Simulator	SCHAFFNER	NSG 435	5866	Oct. 20, 2019,	Oct. 19, 2020

2.5 For RF Field Strength Susceptibility Test

For RF Field Strength Susceptibility Test (A --- site)					
Equipment	Manufacturer	MODEL#	SERIAL#	LASTCAL.	NEXT CAL.
Signal Generator	HP	8648A	3625U00573	Oct. 20, 2019,	Oct. 19, 2020
Amplifier	A&R	500A100	17034	NCR	NCR
Amplifier	A&R	100W/1000M1	17028	NCR	NCR
Audio Analyzer (20Hz~1000KH z)	Panasonic	2023B	202301/428	Oct. 20, 2019,	Oct. 19, 2020
Isotropic Field Probe	A&R	FP2000	16755	Oct. 20, 2019,	Oct. 19, 2020
Antenna	EMCO	3108	9507-2534	NCR	NCR
Log-periodic Antenna	A&R	AT1080	16812	NCR	NCR

2.6 For Electrical Fast Transient /Burst Immunity Test

For Electrical Fast Transient/Burst Immunity Test (A --- site)					
Equipment	Manufacturer	MODEL#	SERIAL#	LASTCAL.	NEXT CAL.
Modula Generator	Schaffner	MODULA 6150	34475	Oct. 20, 2019,	Oct. 19, 2020
INS6501 Stetransformer	Schaffner	INA6501	136	Oct. 20, 2019,	Oct. 19, 2020

2.7.For Surge Test

For Surge Test (A --- site)					
Equipment	Manufacturer	MODEL#	SERIAL#	LASTCAL.	NEXT CAL.
Modula Generator	Schaffner	MODULA 6150	34475	Oct. 20, 2019,	Oct. 19, 2020
INS6501 Stetransformer	Schaffner	INA6501	136	Oct. 20, 2019,	Oct. 19, 2020

2.8 For Injected Currents Susceptibility Test

For Injected Currents Susceptibility Test (A --- site)					
Equipment	Manufacturer	MODEL#	SERIAL#	LASTCAL.	NEXT CAL.
Signal Generator	SCHAFFNER	NSG 2070	1086	Oct. 20, 2019,	Oct. 19, 2020
CDN	SCHAFFNER	M016	20812	Oct. 20, 2019,	Oct. 19, 2020

2.9 For Magnetic Field Immunity Test

For Magnetic Field Immunity Test (A --- site)					
Equipment	Manufacturer	MODEL#	SERIAL#	LASTCAL.	NEXT CAL.



Magnetic field generator	Schaffner	MFO6501	34299	Oct. 20, 2019,	Oct. 19, 2020
Magnetic field loop antenna	Schaffner	INA702	148	Oct. 20, 2019,	Oct. 19, 2020
MC2630	EM Test	MC2630	N/A	Oct. 20, 2019,	Oct. 19, 2020
Magnetic	Coils EM Test	MS100	0500-19	Oct. 20, 2019,	Oct. 19, 2020

2.10 For Voltage Dips Interruptions Test

For Voltage Dips Interruptions Test (A --- site)					
Equipment	Manufacturer	MODEL#	SERIAL#	LASTCAL.	NEXT CAL.
Modula Generator	Schaffner	MODULA 6150	34475	Oct. 20, 2019,	Oct. 19, 2020
INS6501 Stetransformer	Schaffner	INA6501	136	Oct. 20, 2019,	Oct. 19, 2020

3. POWER LINE CONDUCTED EMISSION TEST

3.1. Block Diagram of Test Setup

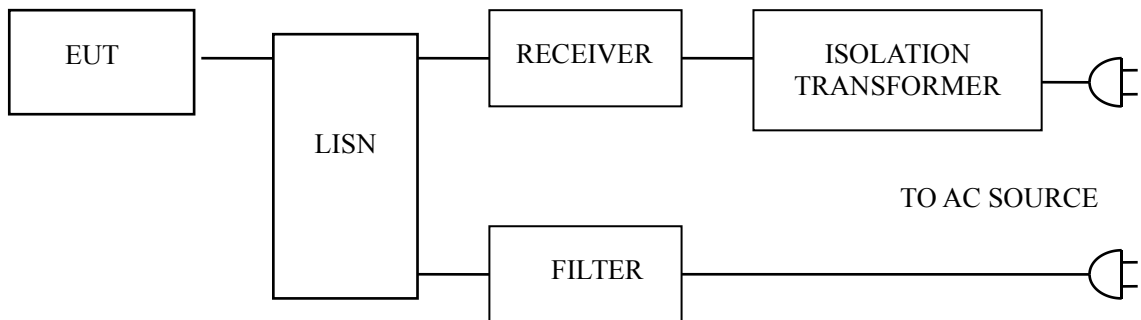

3.2. Test Standard

EN 60601-1:2006+A12:2014

3.3. Power Line Conducted Emission Limit

Frequency MHz	Limits dB(μV)	
	Quasi-peak Level	Average Level
0.15 ~ 0.50	66 ~ 56*	56 ~ 46*
0.50 ~ 5.00	56	46
5.00 ~ 30.00	60	50

Notes: 1. *Decreasing linearly with logarithm of frequency.
2. The lower limit shall apply at the transition frequencies.

3.4. EUT Configuration on Test

The following equipments are installed on conducted emission test to meet EN 60601-1:2006+A12:2014 requirement and operating in a manner which tends to maximize its emission characteristics in a normal application.

3.4.1 FINGERTIP PULSE OXIMETER(EUT)

Model Number : **WLX501**

Manufacturer : **Shenzhen Wanlianxin Electronic Co., Ltd.**

3.5. Operating Condition of EUT

- 3.5.1 Setup the EUT and simulators as shown in Section 3.1.
- 3.5.2 Turn on the power of all equipments.
- 3.5.3 Let the EUT work in test modes (On) and test it.

3.6. Test Procedure

The EUT is put on the ground and connected to the AC mains through a Artificial Mains Network (AMN). This provided a 50ohm coupling impedance for the tested equipments. Both sides of AC line are checked to find out the maximum conducted emission levels according to the **EN 60601-1:2006+A12:2014** regulations during conducted emission test.

The bandwidth of the test receiver (Schwarzbeck Test Receiver PCKL1528) is set at 10KHz.

The frequency range from 150 KHz to 30 MHz is investigated.
The test data and the scanning waveform are listed in Section 3.7 .

3.7. Test Result

PASSED

4. RADIATION EMISSION TEST

4.1 Block Diagram of Test Setup

4.1.1. Block Diagram of EUT Test Setup

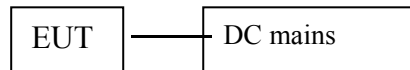

4.1.2. Anechoic Chamber Setup Diagram

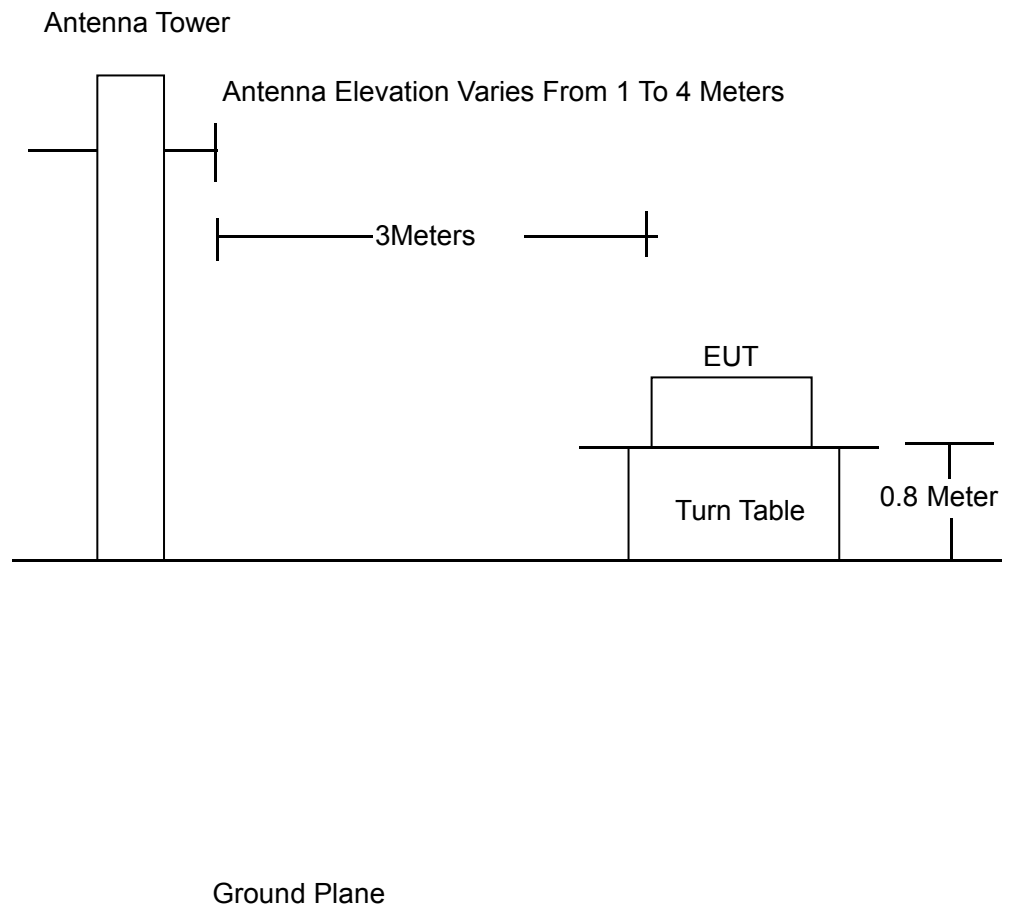

4.2 Test Standard

EN 60601-1:2006+A12:2014

4.3 Radiation Limit

Frequency MHz	Distance (Meters)	Field Strengths Limits dB(μ V)/m
30 ~ 230	3	40.0
230 ~ 1000	3	47.0

Remark:

- (1) Emission level (dB(μ V)/m) = 20 log Emission level (μ V/m)
- (2) The smaller limit shall apply at the cross point between two frequency bands.
- (3) Distance refers to the distance in meters between the measuring instrument, antenna and the closed point of any part of the device or system.

4.4 EUT Configuration on Test

The EN 60601-1:2006+A12:2014 regulations test method must be used to find the maximum emission during radiated emission test.

The configuration of EUT is the same as used in conducted emission test.
Please refer to Section 3.4.

4.5 Operating Condition of EUT

Same as conducted emission test, which is listed in Section 3.5 except the test set up replaced as Section 4.1.

4.6 Test Procedure

The EUT and its simulators are placed on a turned table that is 0.8 meter above the ground. The turned table can rotate 360 degrees to determine the position of the maximum emission level. The EUT is set 3 meters away from the receiving antenna that is mounted on the antenna tower. The antenna can move up and down between 1 meter and 4 meters to find out the maximum emission level. Broadband antenna (calibrated biconical and log periodical antenna) is used as receiving antenna. Both horizontal and vertical polarization of the antenna is set on test. In order to find the maximum emission levels, the interface cable must be manipulated according to EN 60601-1:2006+A12:2014 on radiated emission test.



The bandwidth setting on the field strength meter (Schaffner Test Receiver SCR3501) is set at 120KHz.

The frequency range from 30MHz to 1000MHz is checked.

4.7 Test Result

PASSED

5. ELECTROSTATIC DISCHARGE IMMUNITY TEST

5.1 Block Diagram of Test Setup

5.1.1. Block Diagram of the EUT and the simulators



5.1.2. Test Setup

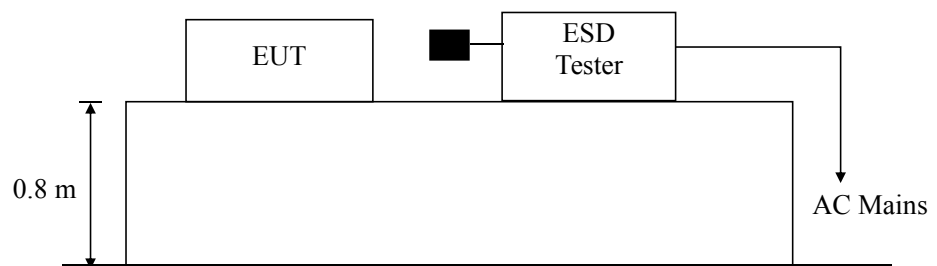

5.2 Test Standard

EN 60601-1-2:2015

Severity Level: 3 / Air Discharge: ± 8 KV

Level: 2 / Contact Discharge: ± 4 KV

5.3 Severity Levels and Performance Criterion

5.3.1 Severity level

Level	Test Voltage Contact Discharge (KV)	Test Voltage Air Discharge (KV)
1.	± 2	± 2
2.	± 4	± 4
3.	± 6	± 8
4.	± 8	± 15
X	Special	Special

5.3.2 Performance criterion : A

- A. The apparatus shall continue to operate as intended during and after the test. No degradation of performance or loss of function is allowed below a performance level specified by the manufacturer, when the apparatus is used as intended.

- B. The apparatus shall continue to operate as intended after the test. No degradation of performance or loss of function is allowed below a performance level specified by the manufacturer, when the apparatus is used as intended. The performance level may be replaced by a permissible loss of performance. During the test, degradation of performance is however allowed.

- C. Temporary loss of function is allowed, provided the function is self-recoverable or can be restored by the operation of the controls.

5.4 EUT Configuration

The following equipments are installed on Electrostatic Discharge Immunity test to meet EN 60601-1-2:2015, requirement and operating in a manner which tends to maximize its emission characteristics in a normal application
The configuration of EUT is the same as used in conducted emission test.
Please refer to Section 3.4.

5.5 Operating Condition of EUT

Same as conducted emission measurement, which is listed in Section 3.5 except the test set up replaced by Section 7.1.

5.6 Test Procedure

5.6.1 Air Discharge:

This test is done on a non-conductive surface. The round discharge tip of the discharge electrode shall be approached as fast as possible to touch the EUT. After each discharge, the discharge electrode shall be removed from the EUT. The generator is then re-triggered for a new single discharge and repeated 10 times for each pre-selected test point. This procedure shall be repeated until all the air discharge completed.

5.6.2 Contact Discharge:

All the procedure shall be same as Section 7.6.1. Except that the tip of the discharge electrode shall touch the EUT before the discharge switch is operated.

5.6.3 Indirect discharge for horizontal coupling plane

At least 10 single discharges (in the most sensitive polarity) shall be applied at the front edge of each HCP opposite the center point of each unit (if applicable) of the EUT and 0.1m from the front of the EUT. The long axis of the discharge electrode shall be in the plane of the HCP and perpendicular to its front edge during the discharge.

5.6.4 Indirect discharge for vertical coupling plane

At least 10 single discharges (in the most sensitive polarity) shall be applied to the center of one vertical edge of the coupling plane. The coupling plane, of dimensions 0.5m X 0.5m, is placed parallel to, and positioned at a distance of 0.1m from the EUT. Discharges shall be applied to the coupling plane, with this plane in sufficient different positions that the four faces of the EUT are completely illuminated.

5.7 Test Results

PASSED.

Please refer to the following pages.



Electrostatic Discharge Test Results

Shenzhen BEL Technology Co., Ltd

Applicant	: Shenzhen Wanlianxin Electronic Co., Ltd.	Test Date	: May.22, 2020	
EUT	: FINGERTIP PULSE OXIMETER	Temperature:	25°C	
M/N	: WLX501	Humidity	: 50%	
Power Supply	: N/A			
Test Engineer	: Allen			
Air Discharge: $\pm 8KV$				
Contact Discharge: $\pm 4KV$ # For each point positive 25 times and negative 25 times discharge				
Test Points	Air Discharge	Contact Discharge	Performance Criterion	Result
Others Slot of the EUT	$\pm 2,4,8KV$	N/A	A	PASSED
Line	$\pm 2,4,8KV$	N/A	A	PASSED
Panel	$\pm 2,4,8KV$	N/A	A	PASSED
Port	$\pm 2,4,8KV$	$\pm 2,4KV$	A	PASSED
VCP	N/A	$\pm 2,4 KV$	A	PASSED
HCP	N/A	$\pm 2,4 KV$	A	PASSED

6.RF EM FIELD (KEY CARRIER) TEST

6.1 Block Diagram of Test Setup

6.1.1. Block Diagram of the EUT and the simulators

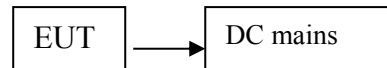

6.1.2. R/S Test Setup

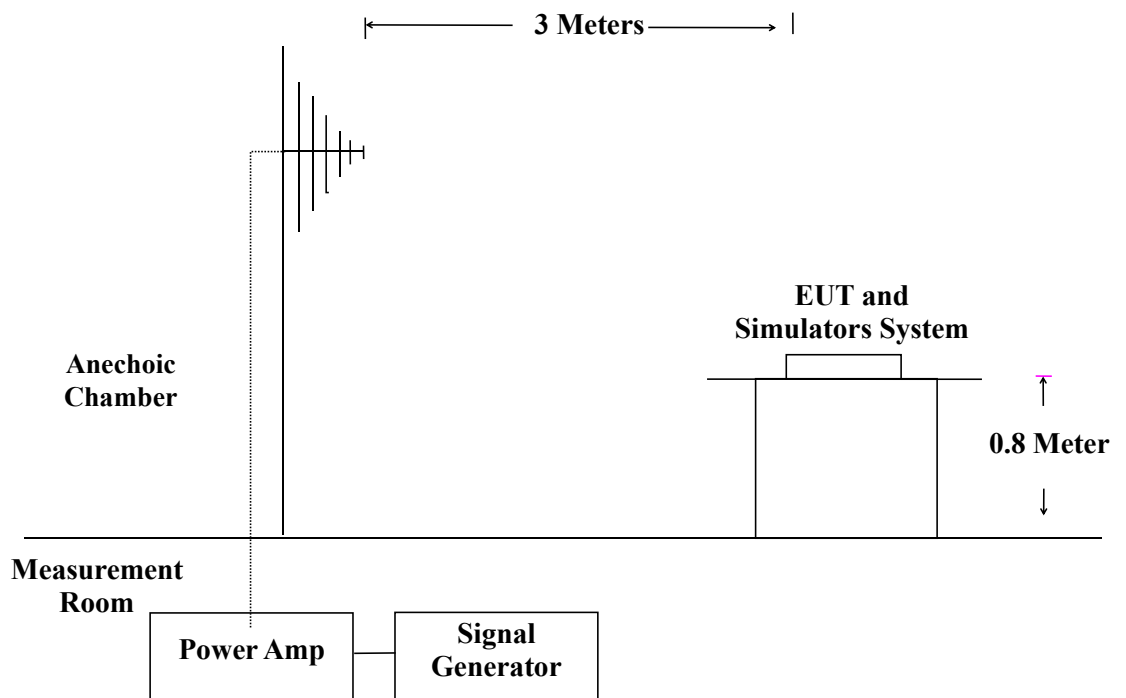

6.2 Test Standard

EN 60601-1-2:2015
Severity Level2, 3V / m

6.3 Severity Levels and Performance Criterion

6.3.1. Severity level

Level	Field Strength V/m
1.	1
2.	3
3.	10
X.	Special

6.3.2. Performance criterion: A

- A、 The apparatus shall continue to operate as intended during and after the test. No degradation of performance or loss of function is allowed below a performance level specified by the manufacturer, when the apparatus is used as intended.
- B、 The apparatus shall continue to operate as intended after the test. No degradation of performance or loss of function is allowed below a performance level specified by the manufacturer, when the apparatus is used as intended. The performance level may be replaced by a permissible loss of performance. During the test, degradation of performance is however allowed.
- C、 Temporary loss of function is allowed, provided the function is self-recoverable or can be restored by the operation of the controls.

6.4 Operating Condition of EUT

Same as conducted emission measurement, which is listed in Section 3.5 except the test set up replaced by Section 8.1.

6.5 Test Procedure

The EUT and its simulators are placed on a turn table which is 0.8 meter above ground. EUT is set 3 meter away from the transmitting antenna which is mounted on an antenna tower. Both horizontal and vertical polarization of the antenna are set on test. Each of the four sides of EUT must be faced this transmitting antenna and measured individually.

All the scanning conditions are as follows :

Condition of Test	Remarks
1. Fielded Strength	3 V/m (Severity Level 2)
2. Radiated Signal	Modulated
3. Scanning Frequency	80 – 1000 MHz
4. Dwell time of radiated	0.0015 decade/s
5. Waiting Time	1 Sec.



6.6 Test Results

PASSED.

Please refer to the following page.



RF EM Field (Key Carrier) Test Results

Shenzhen BEL Technology Co., Ltd

Applicant: Shenzhen Wanlianxin Electronic Co., Ltd.		Test Date : May.22, 2020	
EUT : FINGERTIP PULSE OXIMETER		Temperature : 25°C	
M/N : WLX501		Humidity : 50%	
Field Strength: 3 V/m		Criterion: A	
Power Supply: N/A		Frequency Range: 80 MHz to 1000 MHz	
Test Engineer: Allen			
Modulation: <input checked="" type="checkbox"/> AM <input type="checkbox"/> Pulse <input type="checkbox"/> none 1 KHz 80%			
Test Mode : On			
		Frequency Range : 80-1000MHz	
Steps		1 %	
	Horizontal	Vertical	Result
Front	A	A	Passed
Right	A	A	Passed
Rear	A	A	Passed
Left	A	A	Passed

7. ELECTRICAL FAST TRANSIENT/BURST IMMUNITY TEST

7.1 Block Diagram of EUT Test Setup

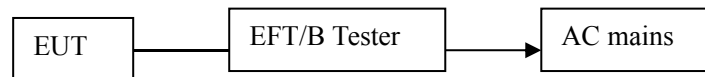

7.2 Test Standard

EN 60601-1-2:2015

7.3 Severity Levels and Performance Criterion

Severity Level 2 at 1KV, Pulse Rise time & Duration: 5 nS / 50 nS

Severity Level:

Open Circuit Output Test Voltage $\pm 10\%$		
Level	On Power Supply Lines	On I/O(Input/Output) Signal data and control lines
1.	0.5KV	0.25KV
2.	1KV	0.5KV
3.	2KV	1KV
4.	4KV	2KV
X.	Special	Special

Performance criterion: B

A. The apparatus shall continue to operate as intended during and after the test. No degradation of performance or loss of function is allowed below a performance level specified by the manufacturer, when the apparatus is used as intended.

B. The apparatus shall continue to operate as intended after the test. No degradation of performance or loss of function is allowed below a performance level specified by the manufacturer, when the apparatus is used as intended. The performance level may be replaced by a permissible loss of performance. During the test, degradation of performance is however allowed.

C. Temporary loss of function is allowed, provided the function is self-recoverable or can be restored by the operation of the controls.

7.4 EUT Configuration on Test

The following equipments are installed on Electrical Fast Transient/Burst Immunity test to meet EN 60601-1-2:2015, requirement and operating in a manner which tends to maximize its emission characteristics in a normal application

The configuration of EUT is the same as used in conducted emission test.
Please refer to Section 3.4.

7.5 Operating Condition of EUT

Same as conducted emission measurement, which is listed in Section 3.5 except the test set up replaced by Section 9.1.

7.6 Test Procedure

EUT shall be placed 0.8m high above the ground reference plane which is a min. 1m*1m metallic sheet with 0.65mm minimum thickness. This reference ground plane shall project beyond the EUT by at least 0.1m on all sides and the minimum distance between EUT and all other conductive structure, except the ground plane beneath the EUT, shall be more than 0.5m

7.6.1. For input and output AC power ports:

The EUT is connected to the power mains by using a coupling device which couples the EFT interference signal to AC power lines. Both polarities of the test voltage should be applied during compliance test and the duration of the test is 2 minutes.

7.6.2. For signal lines and control lines ports:

It's unnecessary to measure.

7.6.3. For DC input and DC output power ports:

For DC ports .It's unnecessary to measure

7.7 Test Results

PASSED.

Please refer to the following pages

EUT:	<u>FINGERTIP PULSE OXIMETER</u>	Temperature:	<u>25°C</u>
M/N:	<u>WLX501</u>	Humidity:	<u>50%</u>
Test Mode:	<u>Working Mode</u>	Test Engineer:	<u>Allen</u>

TEST VOLTAGE	L	N	L+N
±0.5KV	B	B	B
±1KV	B	B	B

8. SURGE TEST

8.1 Block Diagram of EUT Test Setup



8.2 Test Standard

EN 60601-1-2:2015

8.3 Severity Levels and Performance Criterion

Severity Level : Line to Line, Level2 at 1KV;

Line to Earth, Level3 at 2KV.

Severity Level:

Severity Level	Open-Circuit Test Voltage (KV)
1.	0.5
2.	1.0
3.	2.0
4.	4.0
X.	Special

Performance criterion: B

A. The apparatus shall continue to operate as intended during and after the test. No degradation of performance or loss of function is allowed below a performance level specified by the manufacturer, when the apparatus is used as intended.

B. The apparatus shall continue to operate as intended after the test. No degradation of performance or loss of function is allowed below a performance level specified by the manufacturer, when the apparatus is used as intended. The performance level may be replaced by a permissible loss of performance. During the test, degradation of performance is however allowed.

C. Temporary loss of function is allowed, provided the function is self-recoverable or can be restored by the operation of the controls.

8.4 EUT Configuration on Test

The following equipments are installed on Electrical Fast Transient/Burst Immunity test to meet EN 60601-1-2:2015

, requirement and operating in a manner which tends to maximize its emission characteristics in a normal application

The configuration of EUT is the same as used in conducted emission test.
Please refer to Section 3.4.

8.5 Operating Condition of EUT

Same as conducted emission measurement, which is listed in Section 3.5 except the test set up replaced by Section 10.1.

8.6 Test Procedure

- 1) Set up the EUT and test generator as shown on section 10.1
- 2) For line to line coupling mode, provide a 1KV 1.2/50us voltage surge (at open-circuit condition) and 8/20us current surge to EUT selected points.
- 3) At least 5 positive and 5 negative (polarity) test with a maximum 1/min repetition rate are conducted during test.
- 4) Different phase angles are done individually.
- 5) Repeat procedure 2) to 4) except the open-circuit test voltage change from 1KV to 2KV for line to earth coupling mode test.
- 6) Record the EUT operating situation during compliance test and decide the EUT immunity criterion for above each test.

8.7 Test Result

PASSED.

Please refer to the following pages

EUT:	FINGERTIP PULSE OXIMETER	Temperature:	25°C
M/N:	WLX501	Humidity:	50%
Test Mode:	Working Mode	Test Engineer:	Andy

Location	Polarity	Phase Angle	No of Pulse	Pulse Voltage (KV)	Performance Criterion	Result
L-N	±	0	5	1	B	Passed
	±	90	5	1	B	Passed
	±	180	5	1	B	Passed
	±	270	5	1	B	Passed

9. INJECTED CURRENTS SUSCEPTIBILITY TEST

9.1 Block Diagram of EUT Test Setup

9.1.1. Block Diagram of EUT Test Setup

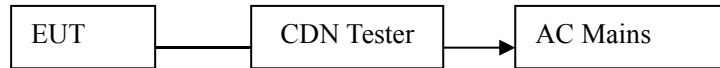

9.1.2. Block Diagram of Test Setup

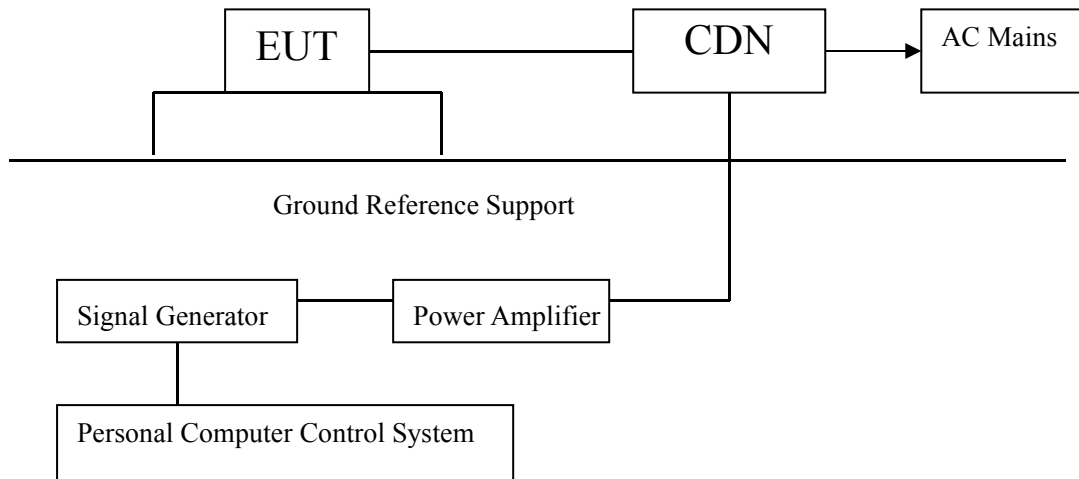

9.2 Test Standard

EN 60601-1-2:2015

9.3 Severity Levels and Performance Criterion

Severity Level 2: 3V(rms), 150KHz ~ 80MHz

Severity Level:

Level	Field Strength V
1.	1
2.	3
3.	10
X.	Special

Performance criterion: A

A. The apparatus shall continue to operate as intended during and after the test. No degradation of performance or loss of function is allowed below a performance level specified by the manufacturer, when the apparatus is used as intended.

B. The apparatus shall continue to operate as intended after the test. No degradation of performance or loss of function is allowed below a performance level specified by the manufacturer, when the apparatus is used as intended. The performance level may be replaced by a permissible loss of performance. During the test, degradation of performance is however allowed.

C. Temporary loss of function is allowed, provided the function is self-recoverable or can be restored by the operation of the controls.

9.4 EUT Configuration on Test

The configuration of EUT is the same as used in conducted emission test. Please refer to Section 3.4.

9.5 Operating Condition of EUT

Same as conducted emission test, which is listed in Section 3.5 except the test set up replaced as Section 9.1.

9.6 Test Procedure

- 1) Set up the EUT, CDN and test generator as shown on section 11.1
- 2) Let EUT work in test mode and measure.
- 3) The EUT and supporting equipments are placed on an insulating support 0.1m high above a ground reference plane. CDN (coupling and decoupling device) is placed on the ground plane at above 0.1-0.3m from EUT. Cables between CDN and EUT are as short as possible, and their height above the ground reference plane shall be between 30 and 50 mm (where possible).
- 4) The disturbance signal described below is injected to EUT through CDN.
- 5) The EUT operates within its operational mode(s) under intended climatic conditions after power on.
- 6) The frequency range is swept from 150KHz to 80MHz using 3V signal level, and with the disturbance signal 80% amplitude modulated with a 1KHz sine wave



- 7) The rate of sweep shall not exceed 1.5×10^{-3} decades/s. Where the frequency is swept incrementally, the step size shall not exceed 1% of the start and thereafter 1% of the preceding frequency value.
- 8) Recording the EUT operating situation during compliance test and decide the EUT immunity criterion for above each test.

9.7 Test Result

PASSED.

Please refer to the following pages

EUT:	FINGERTIP PULSE OXIMETER	Temperature:	25°C
M/N:	WLX501	Humidity:	50%
Test Mode:	Working Mode	Test Engineer:	Andy

Frequency Range(MHz)	Injected Position	Strength	Performance Criterion	Result
150KHz ~80MHz	AC Line	3V(rms), Unmodulated	A	Passed

10. MAGNETIC FIELD IMMUNITY TEST

10.1 Block Diagram of Test Setup

10.1.1 Block Diagram of the EUT



10.1.2 Block Diagram of Test Setup

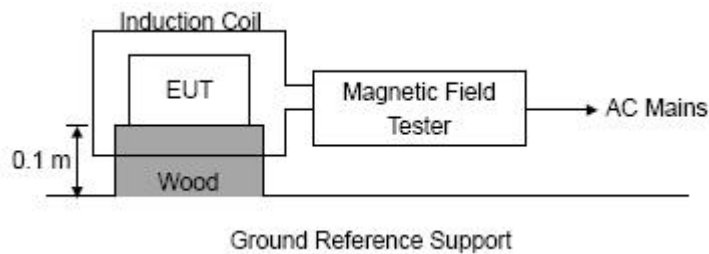

10.2 Test Standard

EN 60601-1-2:2015
Severity Level 1 at 1A/m

10.3 Severity Levels and Performance Criterion

10.3.1 Severity level

Level	Magnetic Field Strength A/m
1.	1
2.	3
3.	10
4.	30
5.	100
X.	Special

10.3.2 Performance criterion: B

- A. The apparatus shall continue to operate as intended during and after the test. No degradation of performance or loss of function is allowed below a performance level specified by the manufacturer, when the apparatus is used as intended.
- B. The apparatus shall continue to operate as intended after the test. No degradation of performance or loss of function is allowed below a performance level specified by the manufacturer, when the apparatus is used as intended. The performance level may be replaced by a permissible loss of performance. During the test, degradation of performance is however allowed.
- C. Temporary loss of function is allowed, provided the function is self-recoverable or can be restored by the operation of the controls.

10.4 EUT Configuration on Test

The configuration of EUT is listed in Section 3.4.

10.5 Operating Condition of EUT

Same as conducted emission test, which is listed in Section 3.5 except the test set up replaced as Section 12.1.

10.6 Test Procedure

The EUT shall be subjected to the test magnetic field by using the induction coil of standard dimensions (1m*1m) and shown in Section 11.1. The induction coil shall then be rotated by 90° in order to expose the EUT to the test field with different orientations.



10.7 Test Results

PASSED.

Please refer to the following page.

Magnetic Field Immunity Test Results

EUT:	FINGERTIP PULSE OXIMETER	Temperature:	25°C
M/N:	WLX501	Humidity:	54%
Test Mode:	Working Mode	Test Engineer:	Andy

Environmental Phenomena	Test specification	Units	Performance Criterion	Result
Magnetic Field	1	A/m	A	PASSED

Note:N/A

11. VOLTAGE DIPS AND INTERRUPTIONS TEST

11.1 Block Diagram of EUT Test Setup



11.2 Test Standard

EN 60601-1-2:2015

11.3 Severity Levels and Performance Criterion

Severity Level:

Input and Output AC Power Ports.

- Voltage Dips.
- Voltage Interruptions.

Environmental Phenomena	Test Specification	Units	Performance Criterion
Voltage Dips	>95 0.5	% Reduction period	B
	30 25	% Reduction period	C
Voltage Interruptions	>95 250	% Reduction period	C

Performance criterion: B, C, C

A. The apparatus shall continue to operate as intended during and after the test. No degradation of performance or loss of function is allowed below a performance level specified by the manufacturer, when the apparatus is used as intended.

B. The apparatus shall continue to operate as intended after the test. No degradation of performance or loss of function is allowed below a performance level specified by the manufacturer, when the apparatus is used as intended. The performance level may be replaced by a permissible loss of performance. During the test, degradation of performance is however allowed.

C. Temporary loss of function is allowed, provided the function is self-recoverable or can be restored by the operation of the controls.

11.4 EUT Configuration on Test

The configuration of EUT is the same as used in conducted emission test. Please refer to Section 3.4.

11.5 Operating Condition of EUT

Same as conducted emission test, which is listed in Section 3.5 except the test set up replaced as Section 11.1.

11.6 Test Procedure

- 1) Set up the EUT and test generator as shown on section 11.1
- 2) The interruption is introduced at selected phase angles with specified duration. There is a 3mins minimum interval between each test event.
- 3) After each test a full functional check is performed before the next test.
- 4) Repeat procedures 2 & 3 for voltage dips, only the level and duration is changed.
- 5) Record any degradation of performance.

11.7 Test Result

PASSED.

Please refer to the following pages

EUT:	FINGERTIP PULSE OXIMETER	Temperature:	25°C
M/N:	WLX501	Humidity:	50%
Test Mode:	Working Mode	Test Engineer:	Andy

Environmental Phenomena	Test Specification	Units	Performance Criterion
Voltage Dips	>95	% Reduction period	B
	0.5		
Voltage Interruptions	30	% Reduction period	C
	25		
Voltage Interruptions	>95	% Reduction period	C
	250		

12. EUT TEST GRAPH

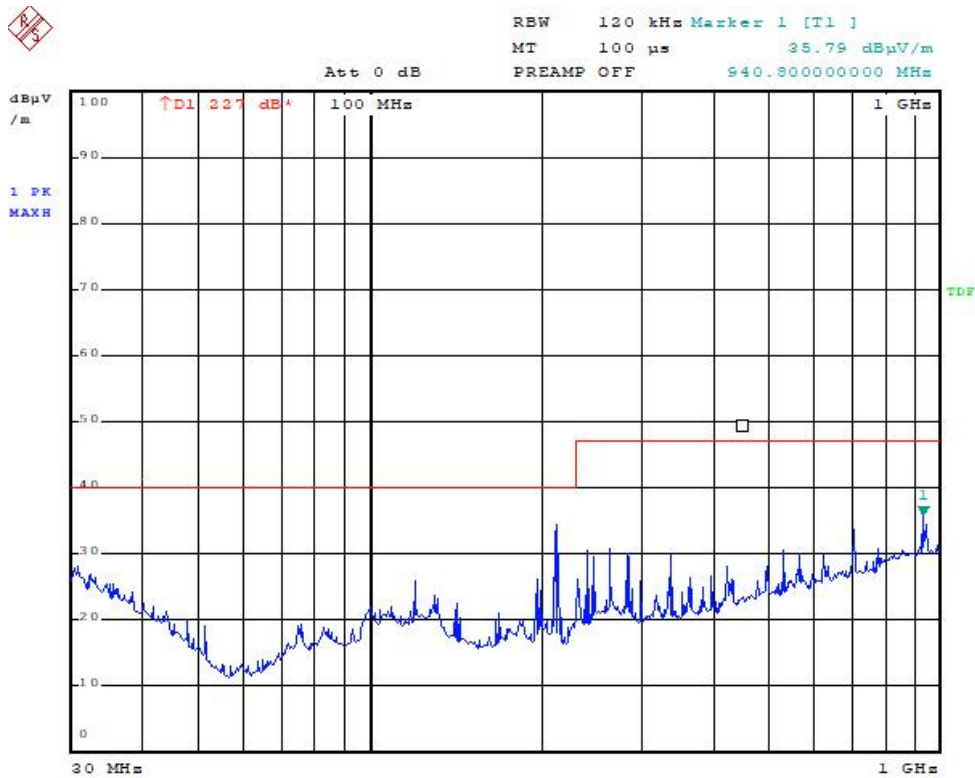
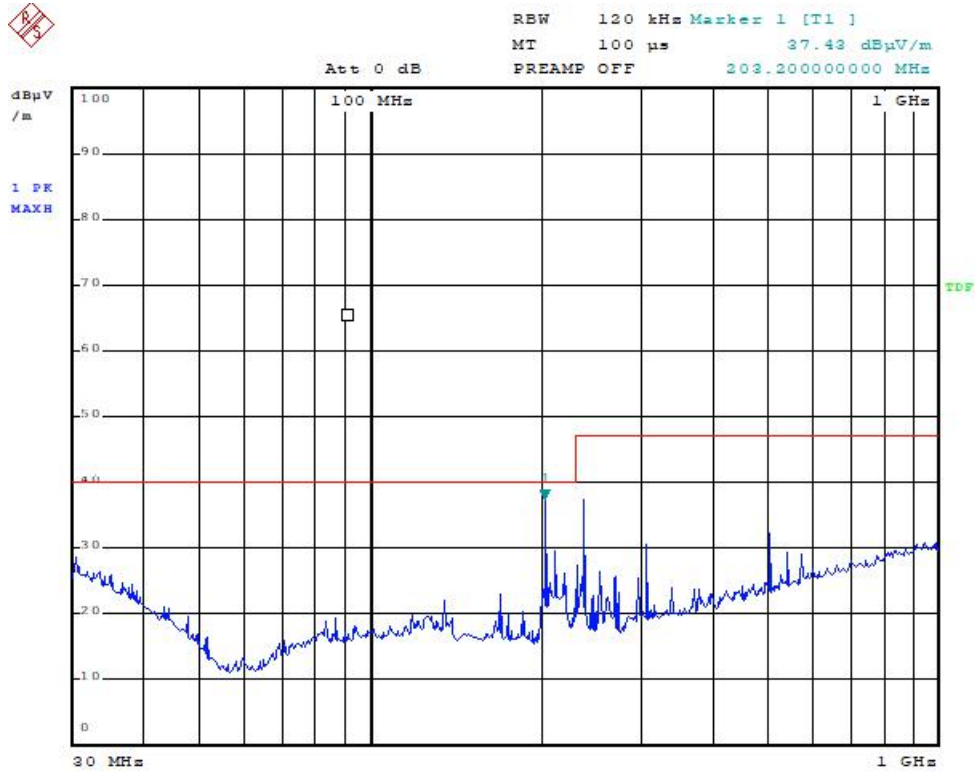

13. EUT PHOTOGRAPHS

EUT Photo 1



EUT Photo 2

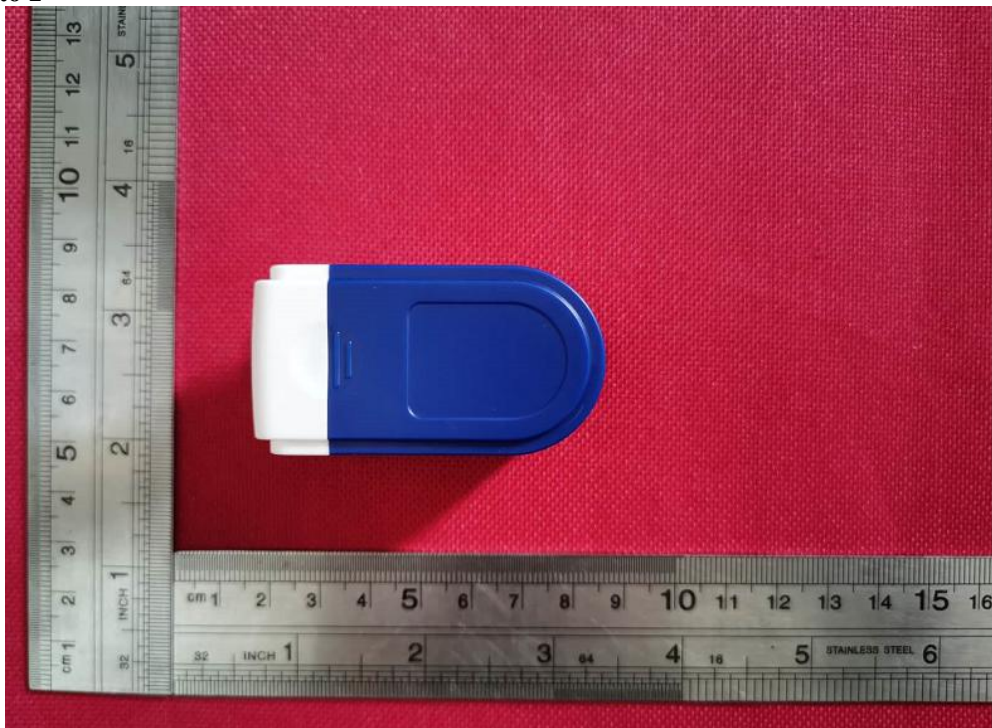

EUT Photo 3

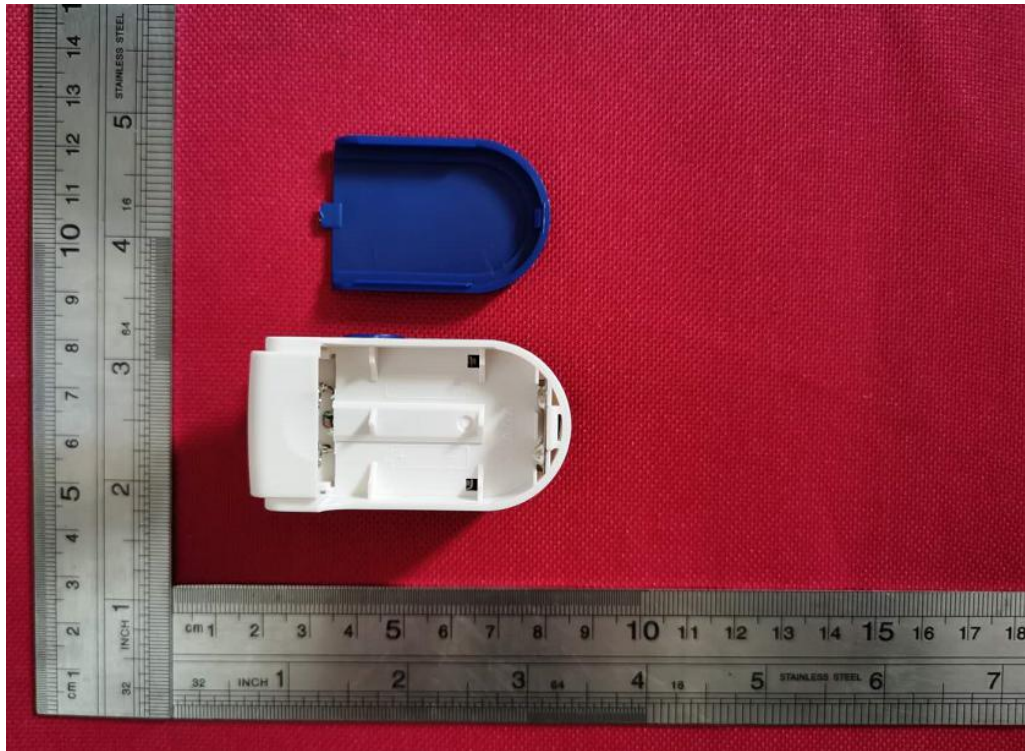

EUT Photo 4

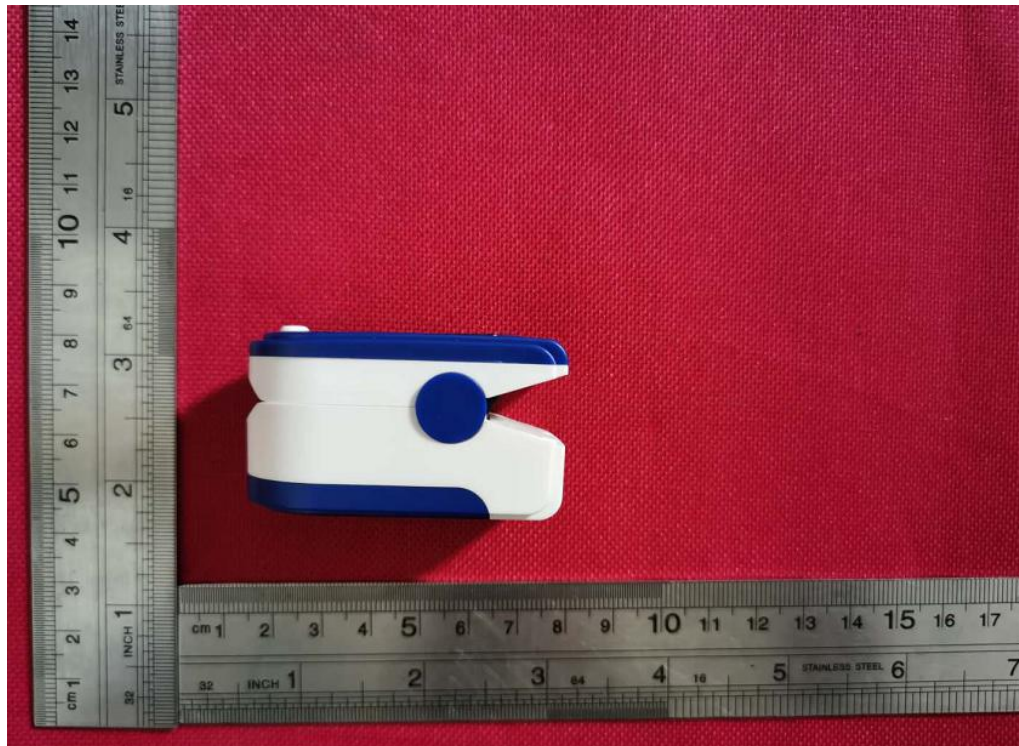

***** END OF REPORT *****